

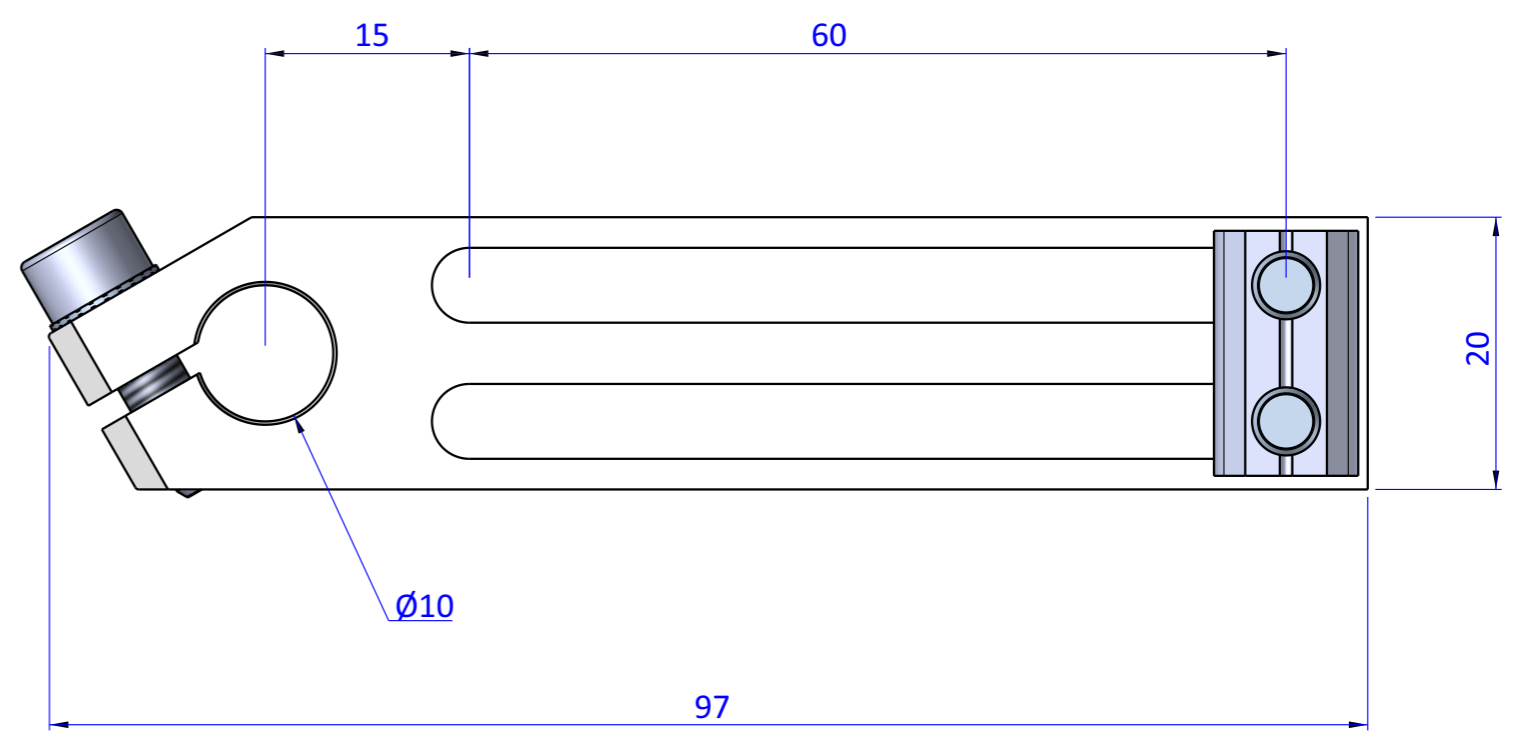

THE PROPERTY OF THE DRAWING IS ESTABLISHED BY LAW. IT IS FORBIDDEN TO PRODUCE OR SHOW IT TO THIRD PART. WITHOUT A WRITTEN AGREEMENT.

Item	Name	Q.ty
1	CA.GWP.5.10	1
2	CA.WSL.1060.VU	1
3	R.05.10	1
4	R.5.SCH	2
5	V.TCE5x18	2

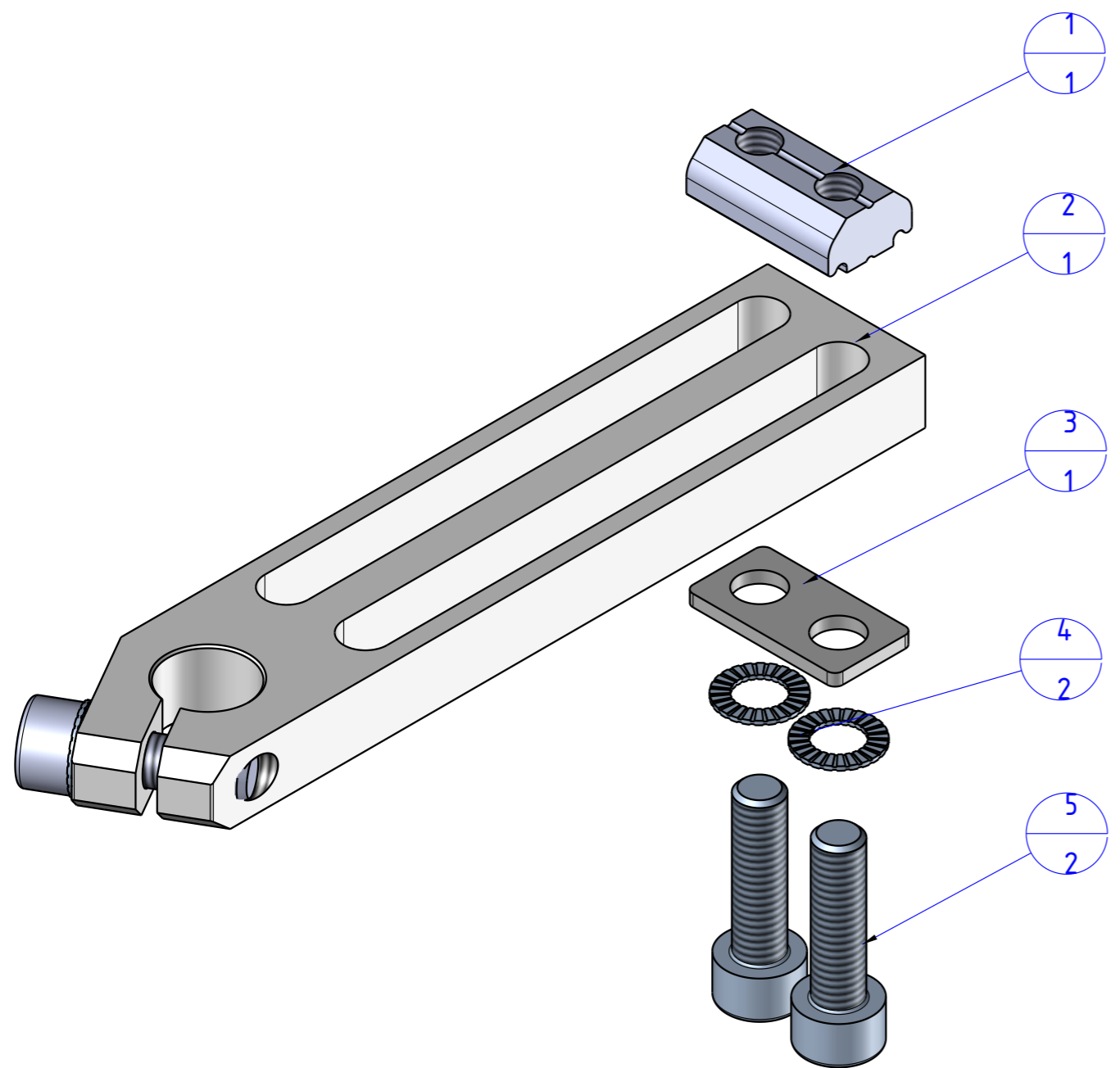

Format A3
UNI 936-76

 FPS FPSERVICES AUTOMATION		DESIGNED FROM		REVIEW
		FPS Automation		A
GENERAL TOLERANCE		DATE		WEIGHT
UNI - ISO 2768		01/03/2021		0,044kg
CLASSE f		CODE		
		CA.WSL.1060.VU.X		CA.WSL.1060.VU.X